

Smart Building and Hybrid Work Solutions

# Cisco Talent and Collaboration Centers



Chicago Look Book



# Chicago Look Book



## Designing the office for the Hybrid World

Located in the historic Old Post Office, Cisco's Chicago Talent and Collaboration Center is an example of what's possible when space design, technology, and culture all come together.

Occupying ~130,000 square feet (~12,077 square meters) of space, the office combines sales, operations, and engineering organizations that were previously geographically dispersed. Built for the world of hybrid work, technology is omnipresent and is as much the foundation of the office as the concrete used during the construction of the building in 1921. With the latest in Meraki networking, over 120 video-enabled meeting spaces, intelligent hot desking, and a state-of-the-art demo center, this office is a destination for collaboration, learning, and innovation.

The intent of this document is to highlight the details, components and partners used in the creation of this office. Any reference herein to any specific commercial products or service does not necessarily constitute or imply its endorsement or recommendation.

|   |    |
|---|----|
| ▶ Key Design & Implementation Partners        | 3  |
| ▶ Enabling Technology                         | 4  |
| ▶ Floor Plan                                  | 9  |
| ▶ Hot Desk                                    | 10 |
| ▶ Video Booth                                 | 12 |
| ▶ Quiet Room                                  | 15 |
| ▶ Traditional Huddle Room                     | 18 |
| ▶ Casual Huddle Room                          | 21 |
| ▶ Brainstorming Huddle Room - Standard Height | 24 |
| ▶ Brainstorming Huddle Room - Counter Height  | 27 |
| ▶ Small Collaboration Room                    | 30 |
| ▶ Medium Collaboration Room - Dual Display    | 33 |
| ▶ Medium Brainstorming Room                   | 36 |
| ▶ Large Collaboration Room                    | 39 |
| ▶ Extra Large Briefing Room                   | 42 |
| ▶ Resources                                   | 45 |

# Key Design & Implementation Partners



---

Owners Representative  
& Project Management



---

Architectural  
Design Services



---

Construction  
Management



---

Collaboration Design  
& Implementation Services



---

Interiors & Furnishings



# Enabling Technology

## Smart Cameras and Sensors



### High-definition Indoor Security Cameras

Providing local storage of video and advanced object detection to support people counting.

### Cisco Meraki Sensors

The Cisco Meraki MT product family is a line of cloud managed sensor that is simple to configure and deploy due to its integration via the Meraki dashboard and the use of BLE technology.

**Cisco Meraki MV22**  
Compact Dome Camera



**Cisco Meraki MT14**  
(Indoor Air Quality Sensor)



**Cisco Meraki MT10**  
(Indoor Temp/Humidity)



**Cisco Meraki MT20**  
(Open/Closed Door)



# Enabling Technology

## Cisco Smart Workspaces



Workplace visualization tool, leveraging data sources across all technology platforms to help employees make better decisions within the work environment.



Overall floor occupancy from smart cameras at points of entry/exit

Indoor air quality from wired sensors in lighting platform, Cisco collaboration devices in collaboration spaces/ individual spaces

Desk occupancy from Cisco Desk Series devices located at hotdesks

Collaboration space availability using presence and people counting data from Cisco collaboration devices

# Enabling Technology

## Networking Elements



The Cisco Meraki MS350 and MS390 series provides high-performance access switching for large enterprise and campus networks.

Meraki MS350/MS390



Meraki MS390



The Cisco Meraki MR56 is a cloud-managed 8x8:8 802.11ax wireless access point that is designed for next-generation deployments in offices. The MR56 offers high throughput, enterprise-grade security, and simple management.

Meraki MR56 High Density Access Point



# Enabling Technology

## Cisco Video Devices



### Cisco Room Bar

Integrated video conferencing system for small rooms



### Cisco Room Bar Pro

Dual-camera integrated video conferencing system for medium rooms



### Cisco Room Kit EQ

An AI-powered collaboration solution for large collaboration rooms and boardrooms



### Cisco Room Kit Pro

A powerful and flexible room device bundle for very large rooms and custom AV integration scenarios.



### Cisco Board Pro G2

Interactive collaboration board available in 55" and 75" screen sizes



### Cisco Room Kit EQX

Powerful dual-screen collaboration system with integrated sound system



### Cisco Desk Pro

Studio-quality desktop collaboration with a 27" screen, used in Quiet Rooms



### Cisco Desk

All-in-one desktop collaboration device with a 24" screen, used on hot desks



### Cisco Desk Mini

Desktop collaboration system with a 15" screen, used in video booth and banquettes



### Cisco Ceiling Microphone Pro

Intelligent beam-forming mic, easy-to-deploy and gives great room coverage



### Cisco Table Microphone Pro

Advanced beamforming table microphones.



### Cisco Room Vision PTZ

Premium pan-tilt-zoom



# Enabling Technology

## Room Signage



Cisco Room Navigator for Wall

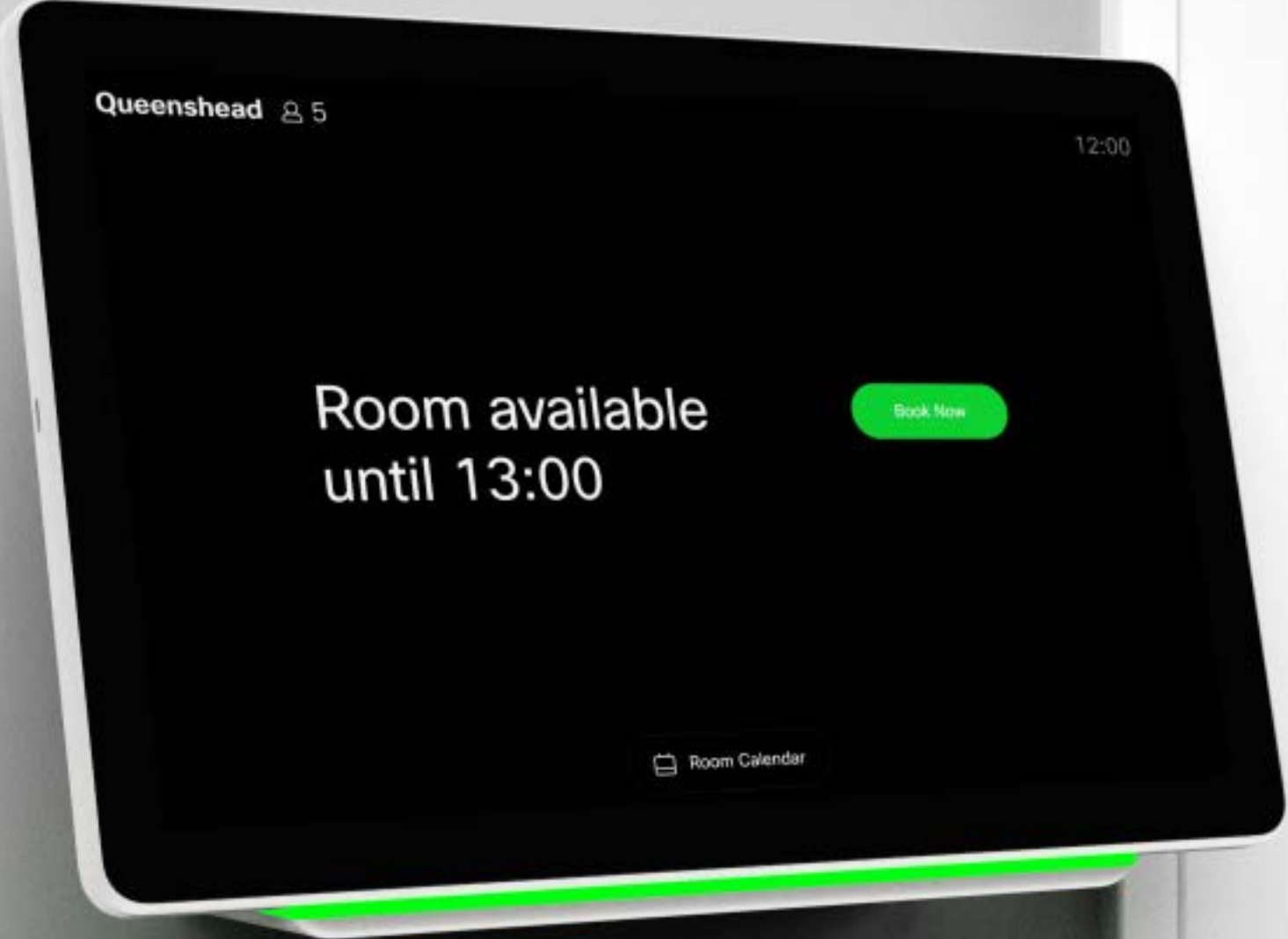

### Bookable Rooms

Cisco Room Navigator for Wall – through its integration with O365, Exchange and Google Calendar – enables seamless room booking, calendar view, meeting information, and meeting extension with a few taps on the touch screen.



### Adhoc Rooms

The Cisco Room Navigator for Wall uses an in-house developed web app to change the display and LED light based on occupancy, green available, and red for occupied.



# Floor Plan

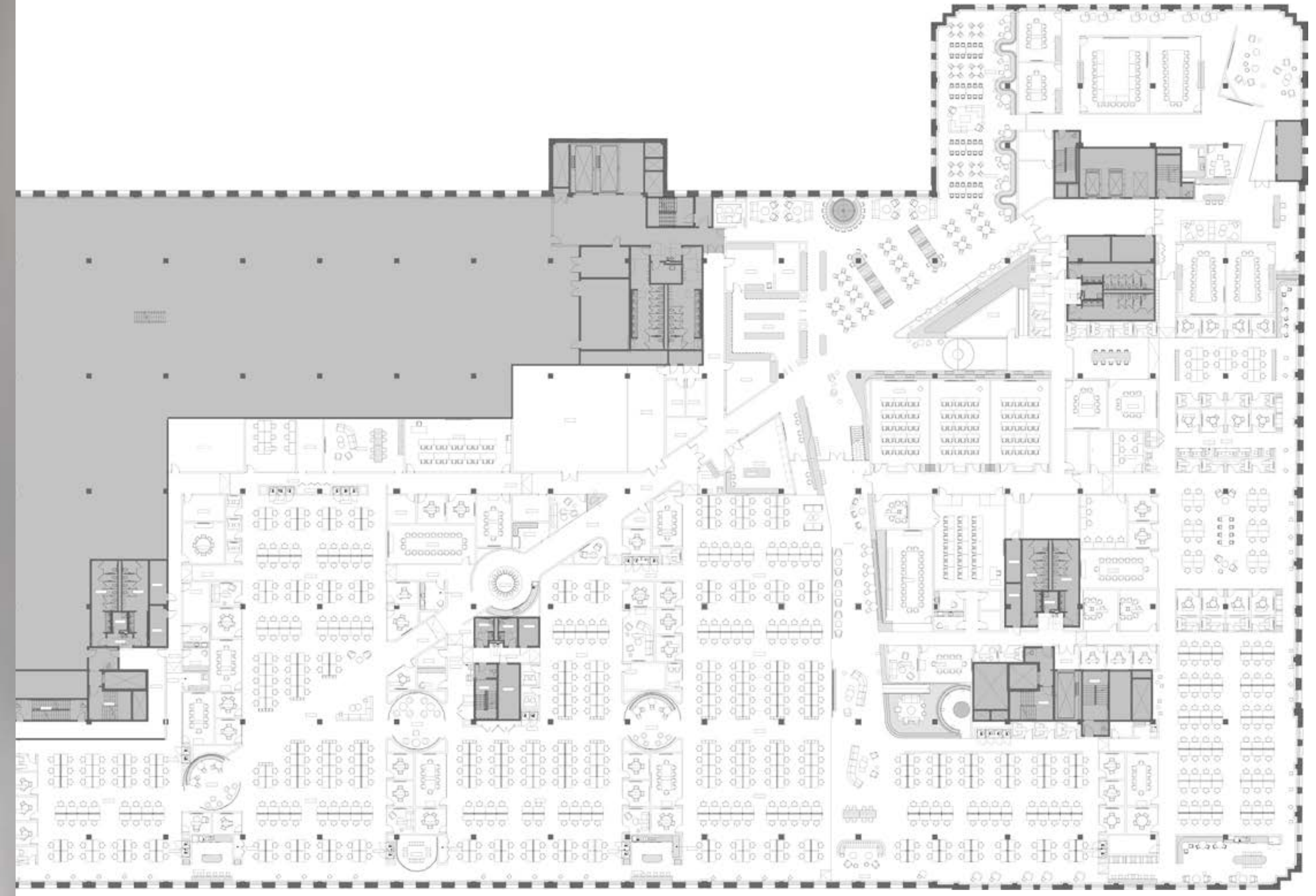

# Hot Desk Overview



Providing areas for people to do focus work or passively participate in a remote meeting is critical in the hybrid work environment, and the hot desk is the perfect space for these activities.

### Features

- Cisco Desk, or a Cisco Desk Phone 9800 Series, Desk Camera and 27” Display
- Teknion Navigate Height-Adjustable Table
- Humanscale Liberty Task chair

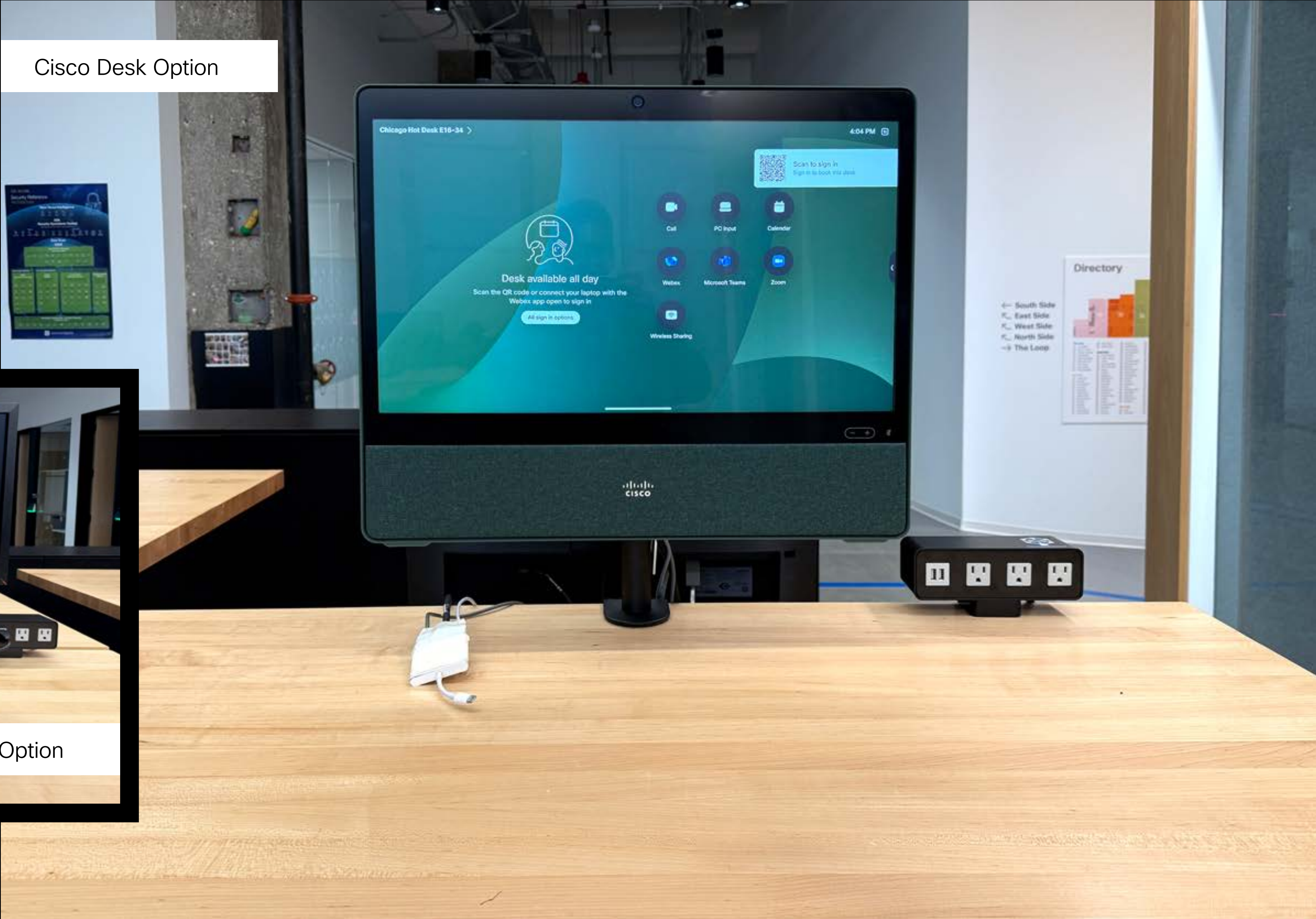

Cisco Desk Option



Cisco Desk Phone Option

# Hot Desk Components



Option 1

Cisco Desk



CISCO



Humanscale Liberty  
Task Chair

Humanscale

Option 2



Cisco Desk Phone  
9800 Series



Cisco Desk Camera



Single 27" Display  
(LG, Panasonic, Samsung, or Sony)

CISCO

LG Panasonic SAMSUNG SONY

Teknion Navigate  
Height Adjustable Table  
with PoE conversion kit



PoE Conversion  
Kit by: mht

teknion

# Video Booth

## Overview



The Video Booth is ideal when you need to jump on that impromptu video call with a colleague, join that weekly team meeting, or simply need a place to whiteboard some new ideas.

### Features

- Wall mounted Cisco Deskpro
- Custom millwork
- Turf Designs Torrent acoustical panels
- Allermuir Kin Stool or Teknion Zones chairs



# Video Booth

## Components



Teknion Zones (CH-21B)



Seat Upholstery  
Luum Heather Tech  
Loam Tech



Base & Seat Pan  
Greystone

teknion

Cisco  
Deskpro



Allermuir Kin Stool

4-leg frame, Full upholstered high back stool



Seat/Back Upholstery  
Designtex Brushed  
Flannel  
3797-801 Light Grey



Frame Finish  
Off-Black  
Powder Coat

Allermuir

# Video Booth

## Room Layout

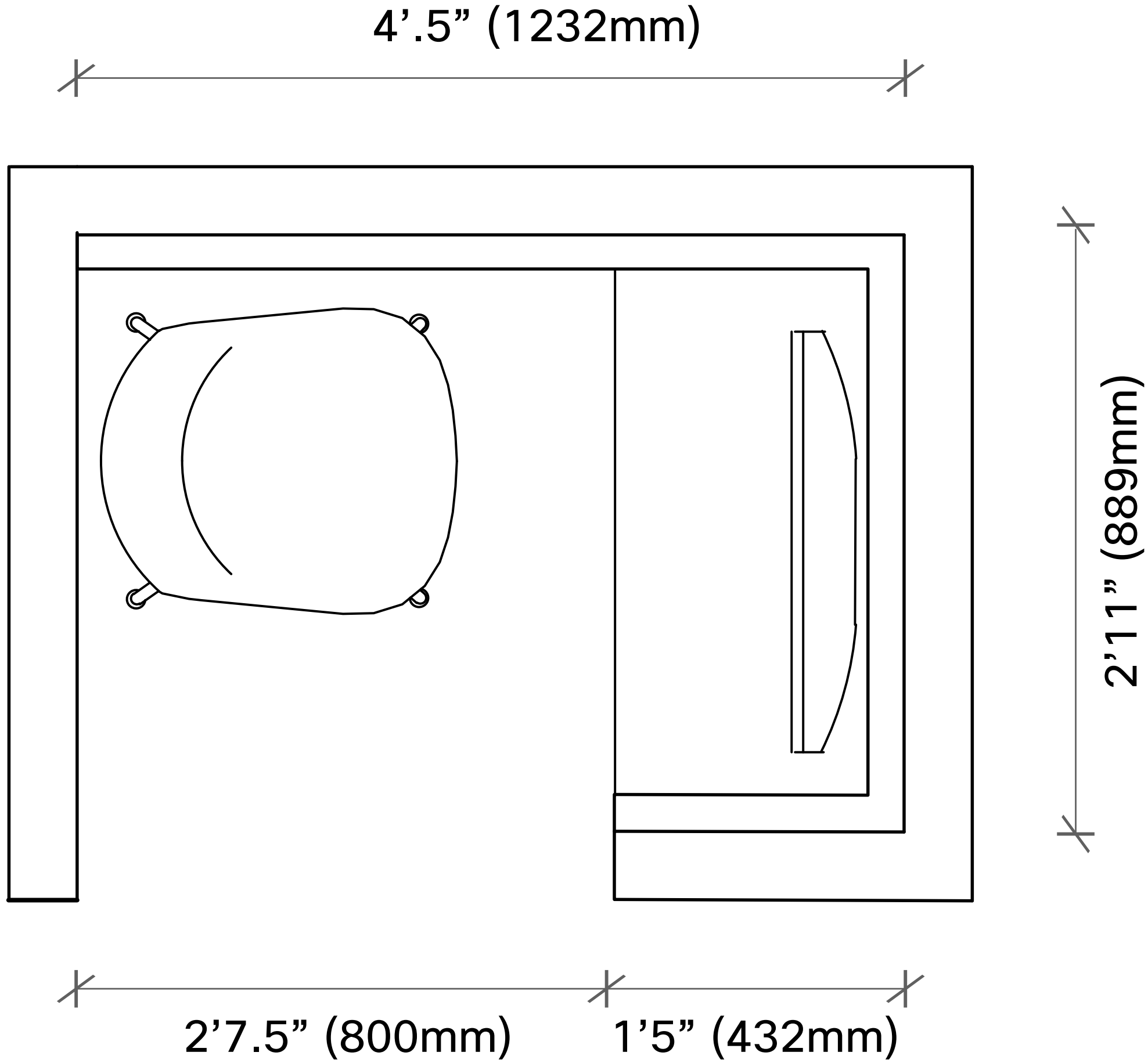

# Quiet Room

## Overview



The one and two-person quiet rooms are the perfect space when you need privacy to take a video call, carry out focused work, collaborate with another individual, or simply need a bit more screen space to get your job done.

### Features

- Cisco Desk (1 person) and Deskpro (2 person)
- Teknion Height-Adjustable Table
- Allermuir Kin chair



# Quiet Room Components



Allermuir Kin CH-42B



Seat Upholstery  
Maharam Manner - Dill

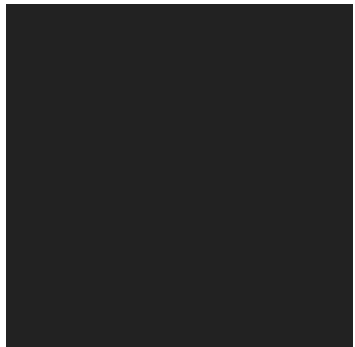

Base  
Off Black Powder Coat

\_\_\_\_ Allermuir

Teknion Navigate  
Height Adjustable Table



\_\_\_\_ teknion

Cisco  
Deskpro



# Quiet Room

## Room Layout



### 1 Person Quiet Room

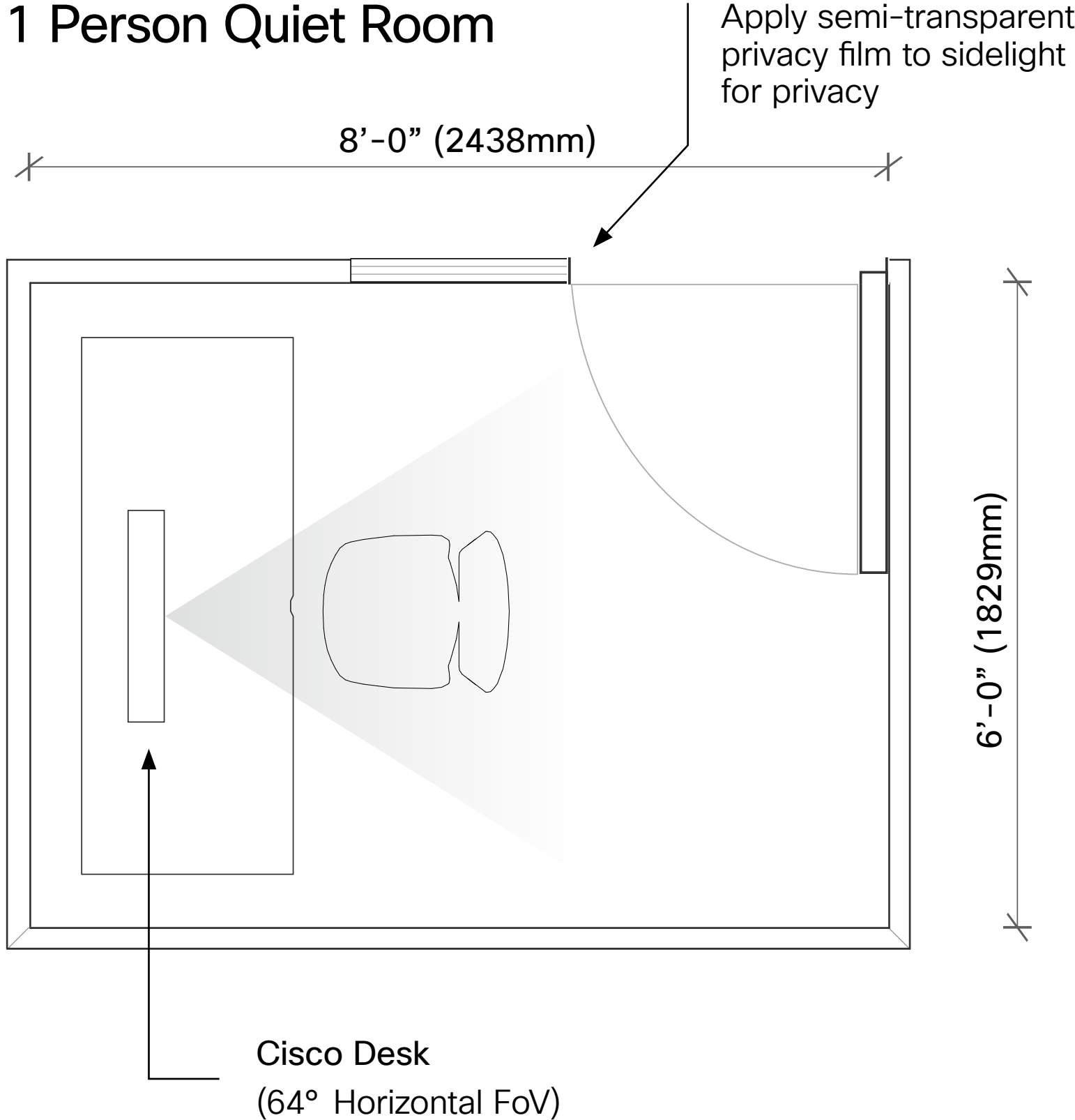

### 2 Person Quiet Room

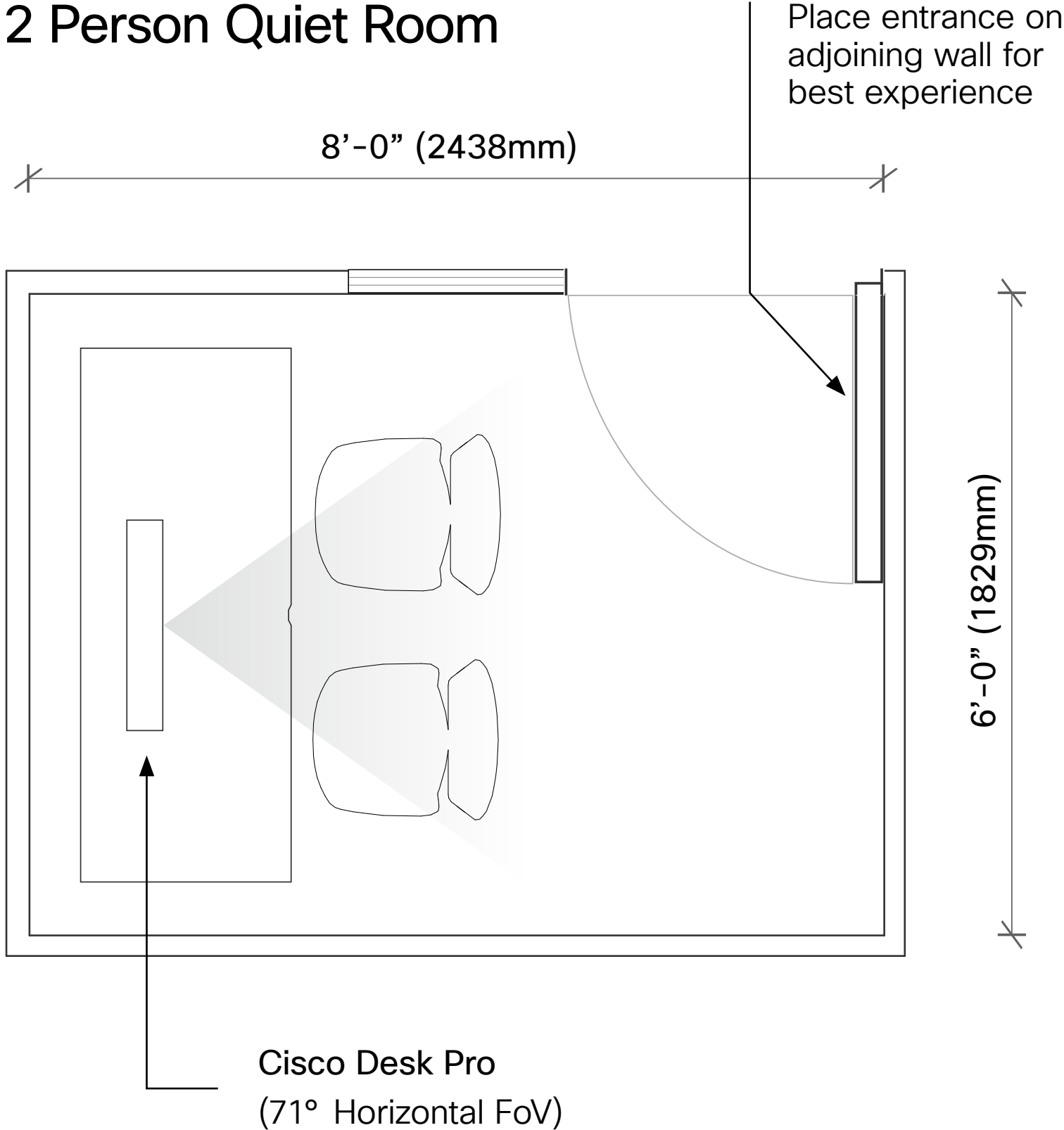

# Traditional Huddle Room

## Overview



Making it easy for small groups to come together to share information, brainstorm, and solve problems is absolutely critical. In the Chicago Talent and Collaboration Centers we've replaced personal offices with dozens of huddle rooms and smaller collaboration spaces, each designed for this exact purpose. All of these spaces are video-enabled, ensuring the right resources can come together, regardless of location.

The Traditional Huddle is the perfect space for small group collaboration, especially when you need to bring in that critically important remote participant. Wireless sharing allows you to use the display in local and virtual meetings effortlessly.

### Features

- Cisco Room Bar
- Single 43" display (LG, Panasonic, Samsung, or Sony)
- Neinkamper Gateway table
- Teknion Zone chairs



# Traditional Huddle Room

## Components



Teknion Zones  
Five-Star Caster Base

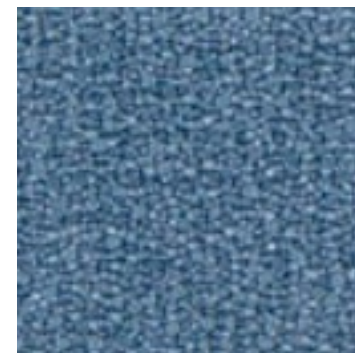

Seat Upholstery  
Maharam Manner  
Tidewater

\_\_\_\_\_ teknion

Nienkamper Gateway Wall Mounted Half Round Table

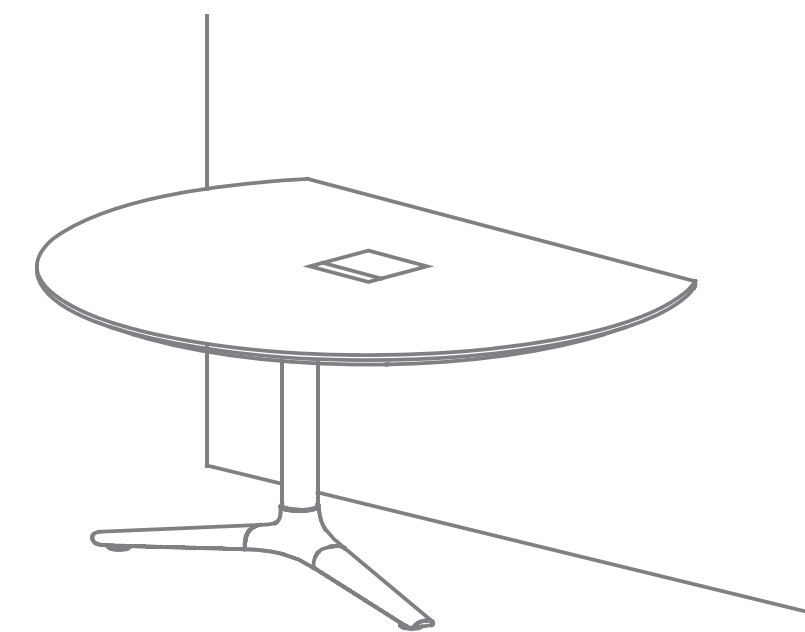

50"L X 58"D X 29"H  
(11270mm L X 1473mm D X 737mm H)

Laminate top  
Wilsonart-Natural Rift 7954-38, fine velvet finish

Base  
Black



Power Forum finish  
Black



\_\_\_\_\_ nienkämper



Cisco Room Bar

\_\_\_\_\_ cisco



Single 43" display  
(LG, Panasonic, Samsung, or Sony)

\_\_\_\_\_ LG Panasonic SAMSUNG SONY

# Traditional Huddle Room

## Room Layout



9' x 9' (2743mm x 2743mm)

Traditional Huddle Room

(3-Chairs)

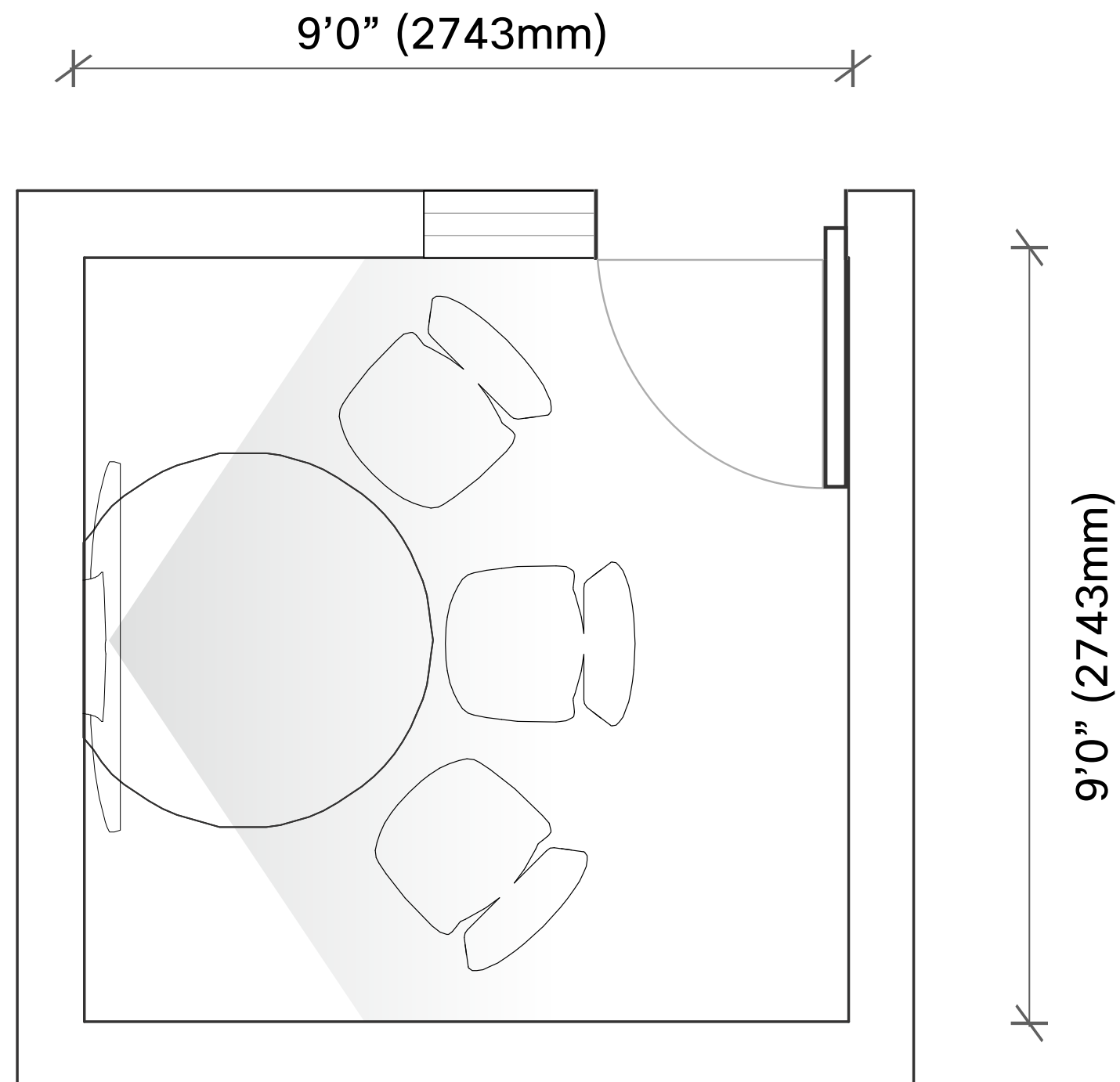

10' x 10' (3048mm x 3048mm)

Traditional Huddle Room

Optimal (4-Chairs)

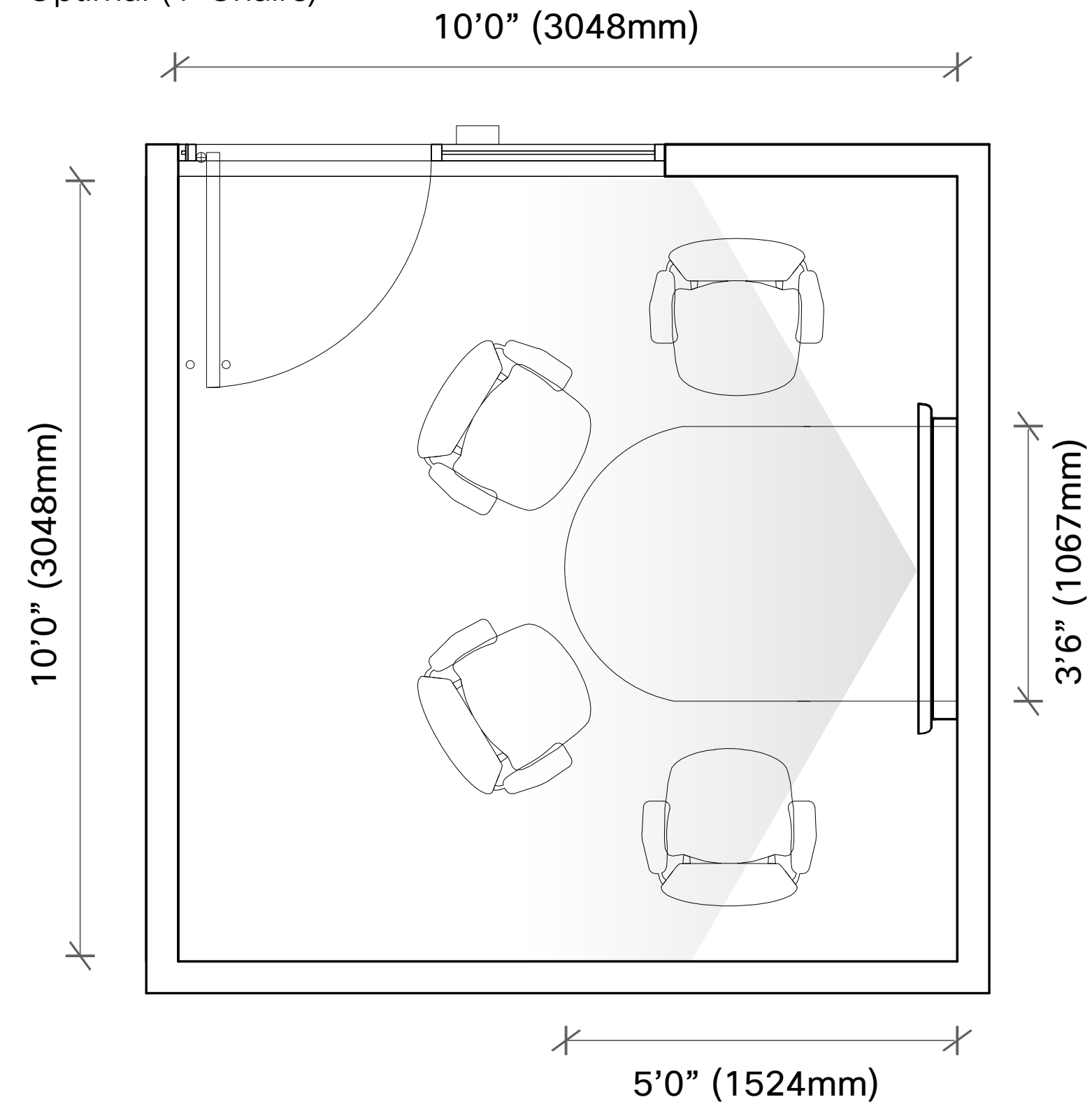

# Casual Huddle Room

## Overview



The Casual Huddle is specifically designed for that informal meeting with colleagues, even when those colleagues are remote. The soft seat is lightweight and highly flexible, allowing the space to adapt to any and all needs.

### Features

- Wall mounted Cisco Room Bar with 55" Display (LG, Panasonic, Samsung, or Sony) or Cisco Board Pro 55
- Stylex Share sectional
- Bernhardt Tour Pouf

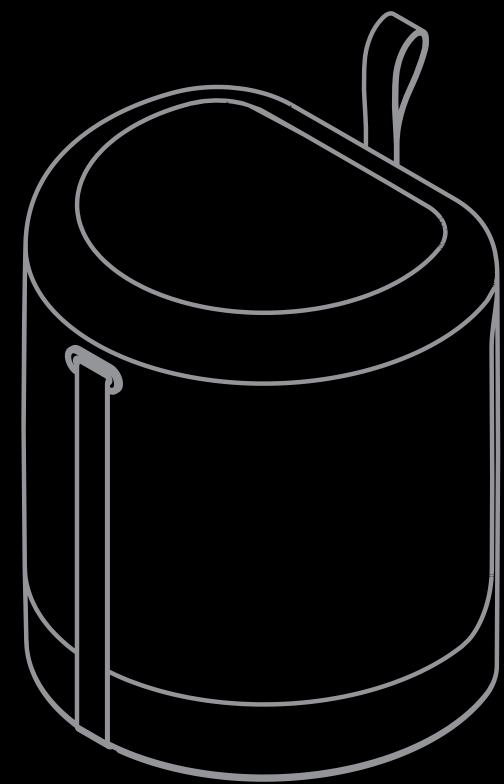

# Casual Huddle Room

## Components



Option 1

Cisco Room Bar



CISCO

Single 55" Display



LG Panasonic SAMSUNG SONY

Option 2

Cisco Board Pro 55



CISCO



Salamander EZ Touch Adjustable Mount

SALAMANDER DESIGNS

Stylex Share SO-10



Seat Upholstery  
Maharam Mode Sycamore

STYLEX

Bernhardt Tour CH-36



Seat  
Focus - Siren

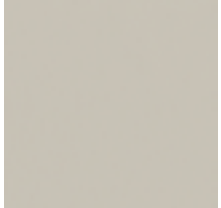

Base  
Bernhardt Excel - Cloud



BERNHARDT | design

Source International LT Laptop Table



Top  
Natural Rift 7954



Base  
RI K



SOURCE

# Casual Huddle Room

## Room Layout

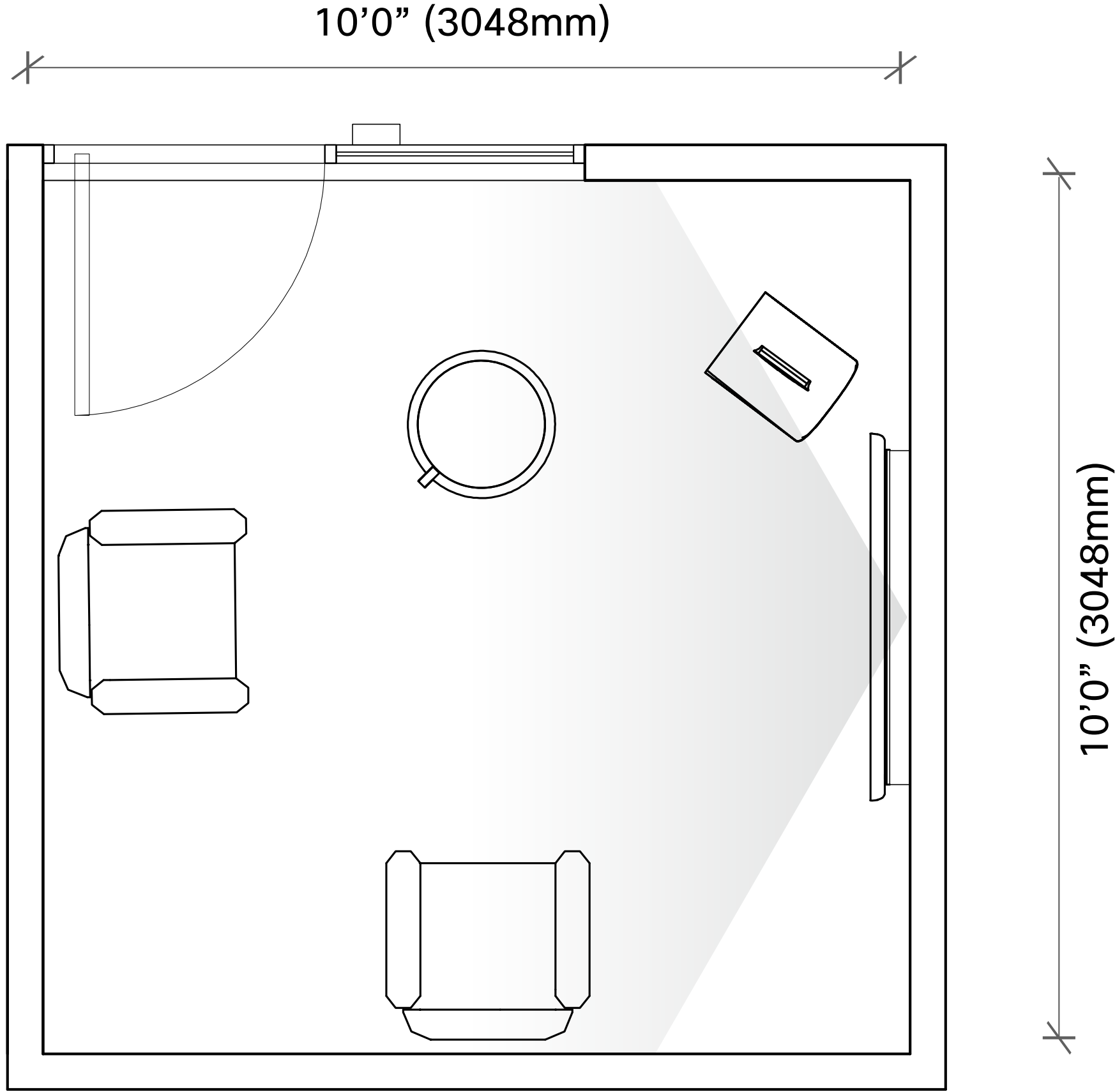

# Brainstorming Huddle Room – Standard Height

## Overview



A perfect space for an ad-hoc brainstorming session, or when you want to co-create with a colleague on an important project.

### Features

- Wall mounted Cisco Board Pro 55
- Neinkamper standard height cone table
- Allermuir Kin chairs
- Salamander EZ Touch Wall Mount (optional)



# Brainstorming Huddle Room - Standard Height



## Components

Allermuir Kin (CH-42A)

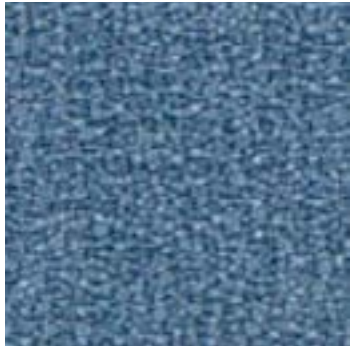

Upholstery  
Maharam  
Manner - Tidewater

Allermuir

Nienkamper | Cone Table



Round Table with Laminate Top  
42"DIA X 29"H  
(1067mm DIA X 737mm H)  
Laminate top  
Wilsonart-Frosty White #1573-60  
Base  
White cone



Power Forum  
1 Power module w/3 ports  
Finish  
White

nienkämper

Cisco Board Pro 55



CISCO

Salamander EZTouch Mount

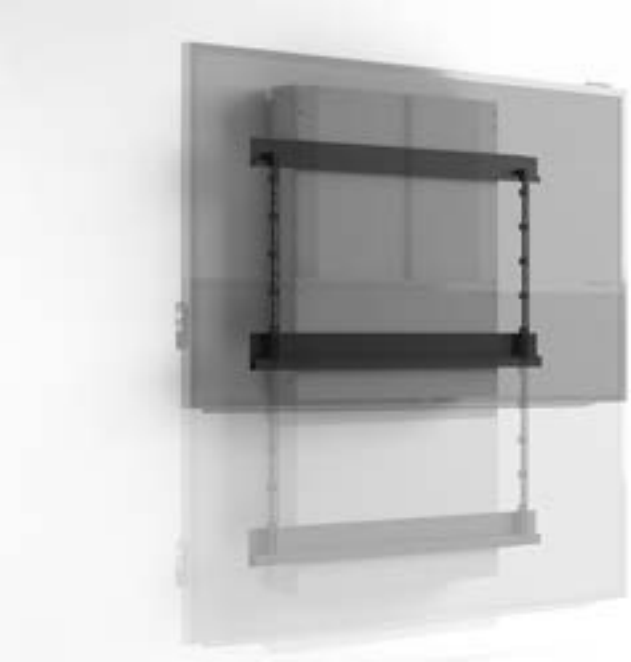

SALAMANDER DESIGNS

# Brainstorming Huddle Room - Standard Height

## Room Layout

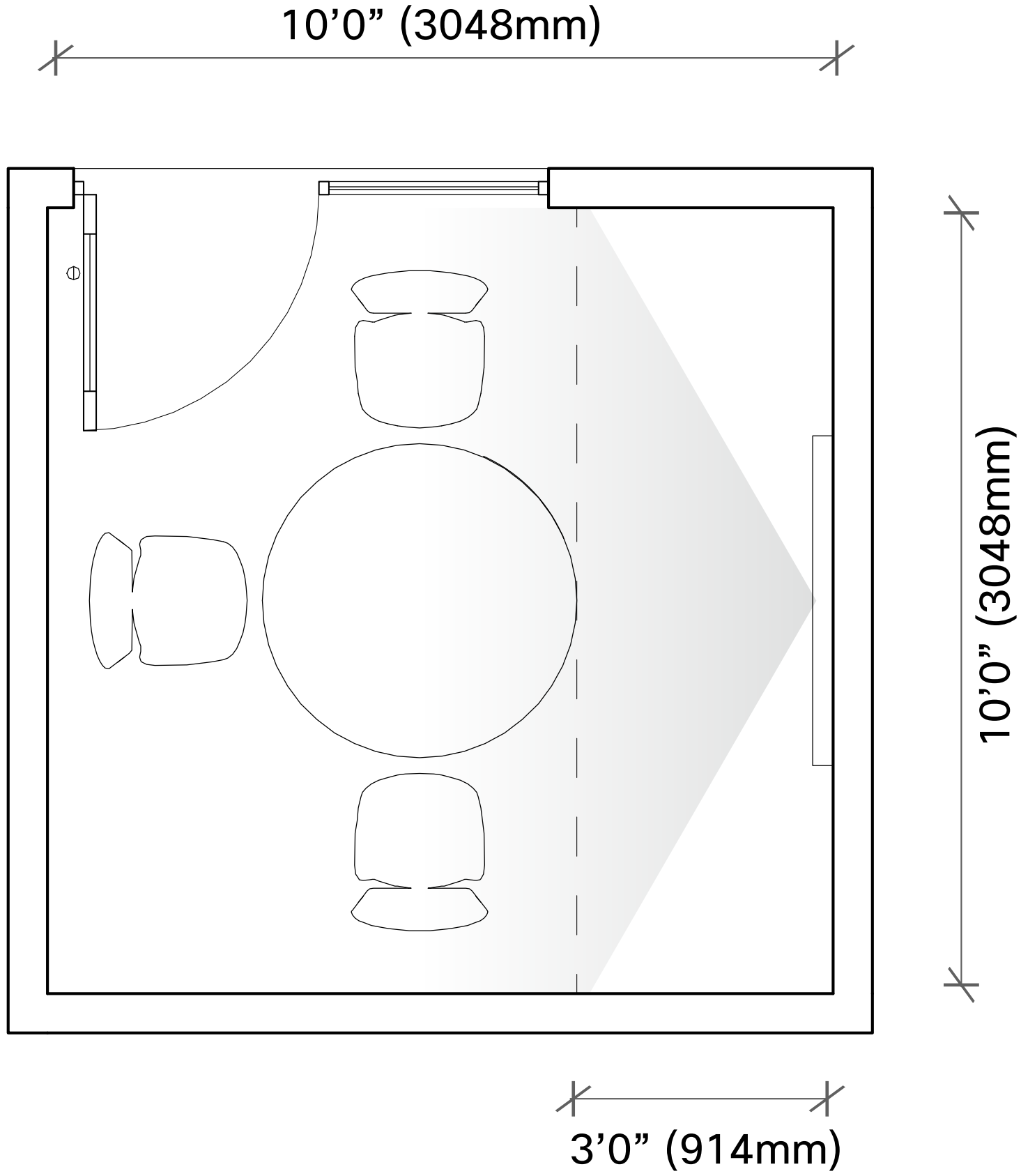

# Brainstorming Huddle Room – Counter Height Overview



Turn a small room into a space for big ideas. The Cisco Board Pro allows users to co-create, share content, or join a video call. The counter height table and chairs change the attendee's posture and encourage people to get up and interact with this all-in-one device.

## Features

- Wall mounted Cisco Board Pro 55
- Nienkamper Vox table
- Humanscale Liberty Task stools

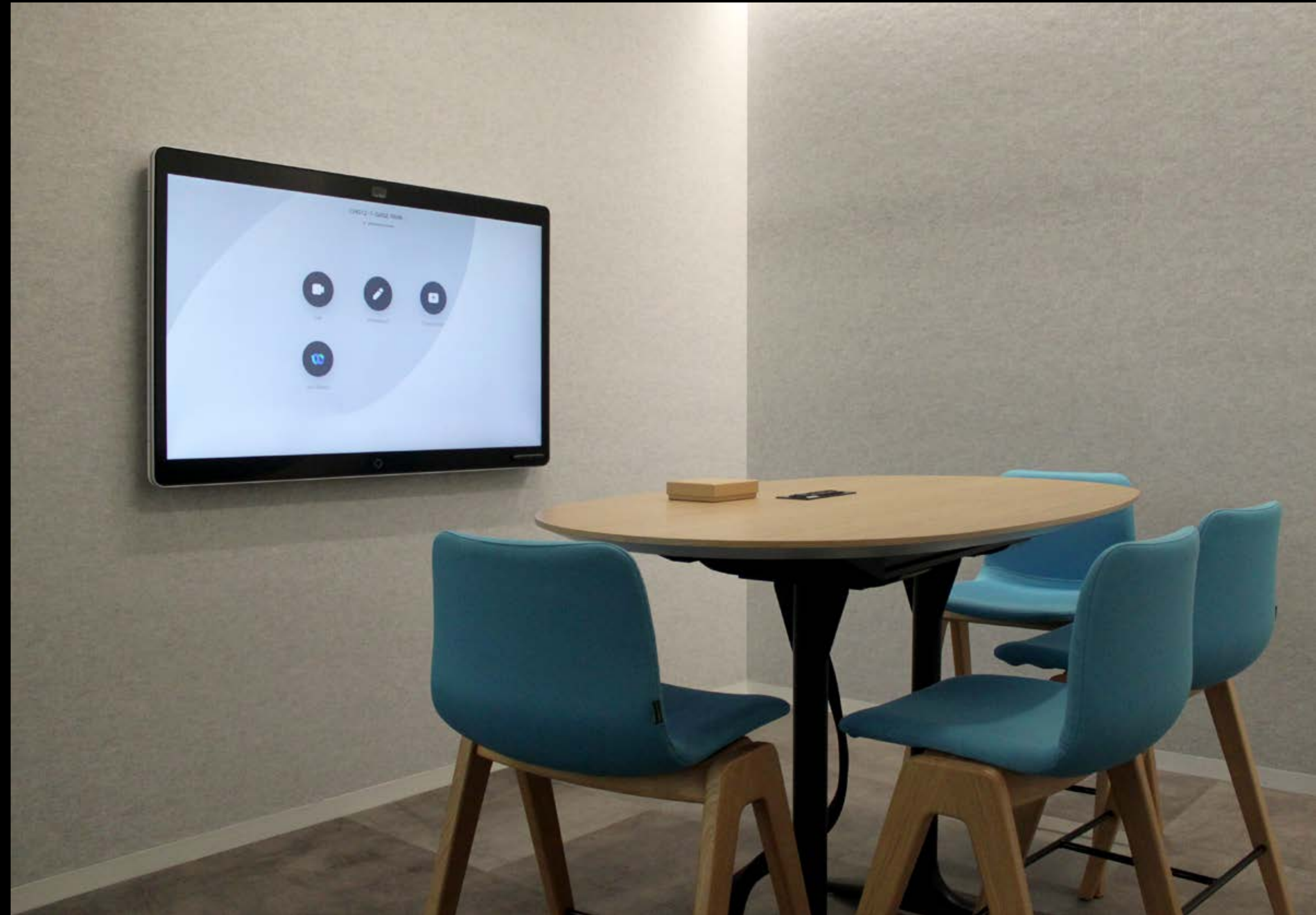

# Brainstorming Huddle Room - Counter Height

## Components



Allermuir Kin (CH-42A)

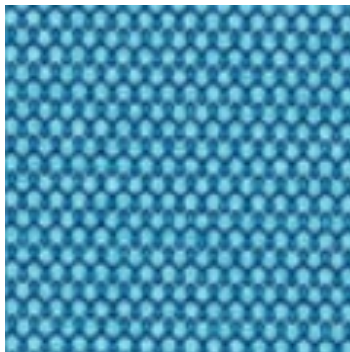

**Upholstery**  
Emit  
(466378-021 Artem)  
55% Post-Industrial Recycled / 45% Post-Consumer Recycled Polyester  
100,000 double rubs

naughtone

Nienkamper Vox Standing Height Table TB-21



Table with Standing Height & Trough  
Trapezoid Shape  
72"L X 60/72"D X 38"H  
(1829mm L X 1524/1829mm D X 965mm H)  
**Laminate top**  
Wilsonart-Natural Rift 7954-38, fine velvet finish  
**Base**  
Black



Power Forum finish  
Black

nienkämper

Cisco Board Pro 55

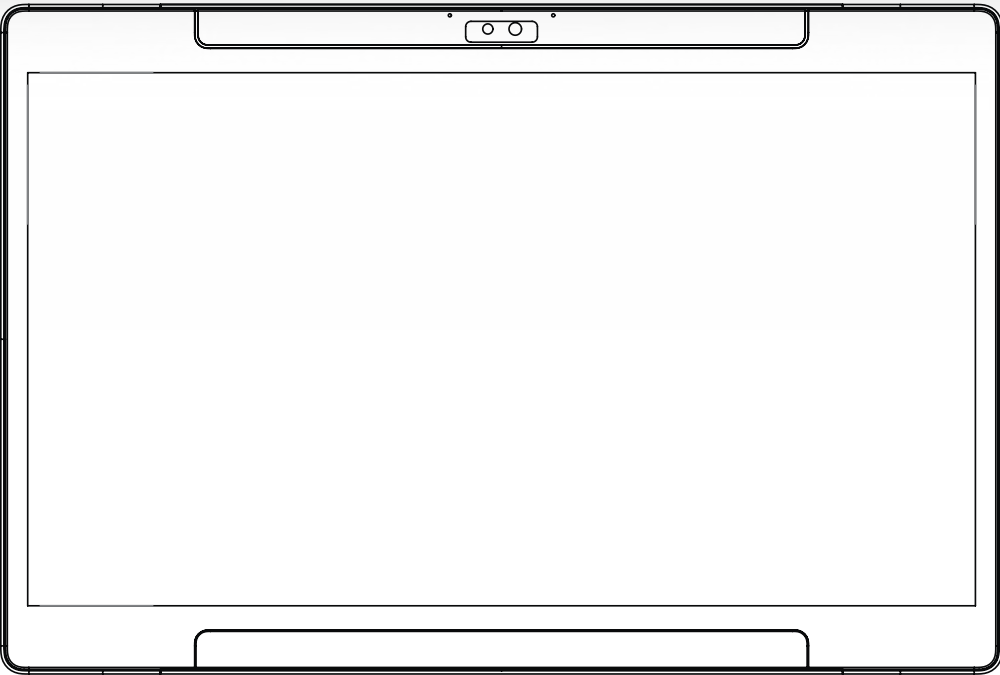

CISCO

# Brainstorming Huddle Room - Counter Height

## Room Layout

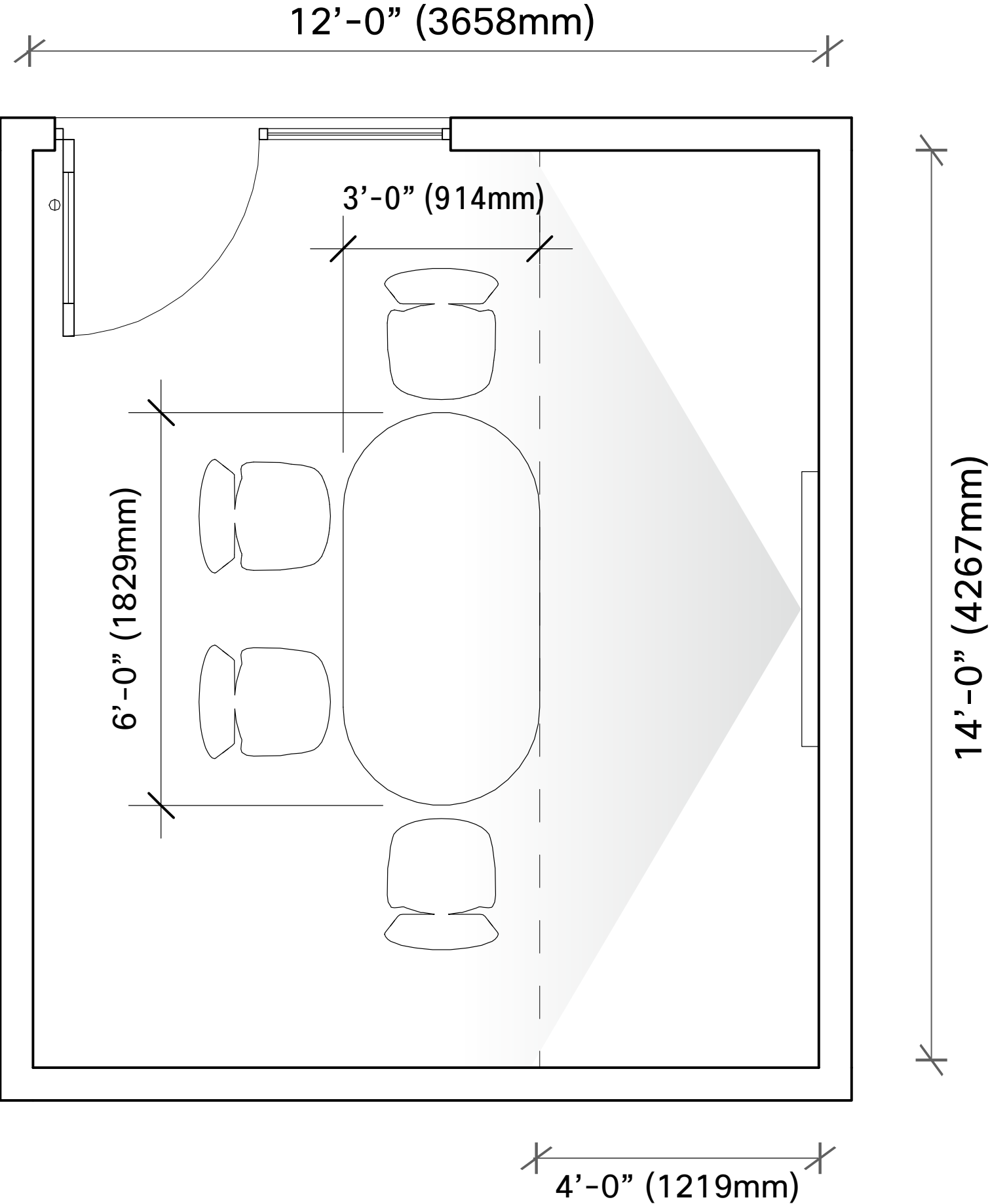

# Small Collaboration Room

## Overview



Small groups get work done. These small meeting rooms are the perfect settings to bring in-person and remote colleagues together. The 120° field of view of the Cisco Room Bar camera makes sure everyone is in view.

### Features

- Cisco Room Bar
- 55" display (LG, Panasonic, Samsung, or Sony)
- Neinkamper Gateway Table
- Humanscale Liberty Task Chair

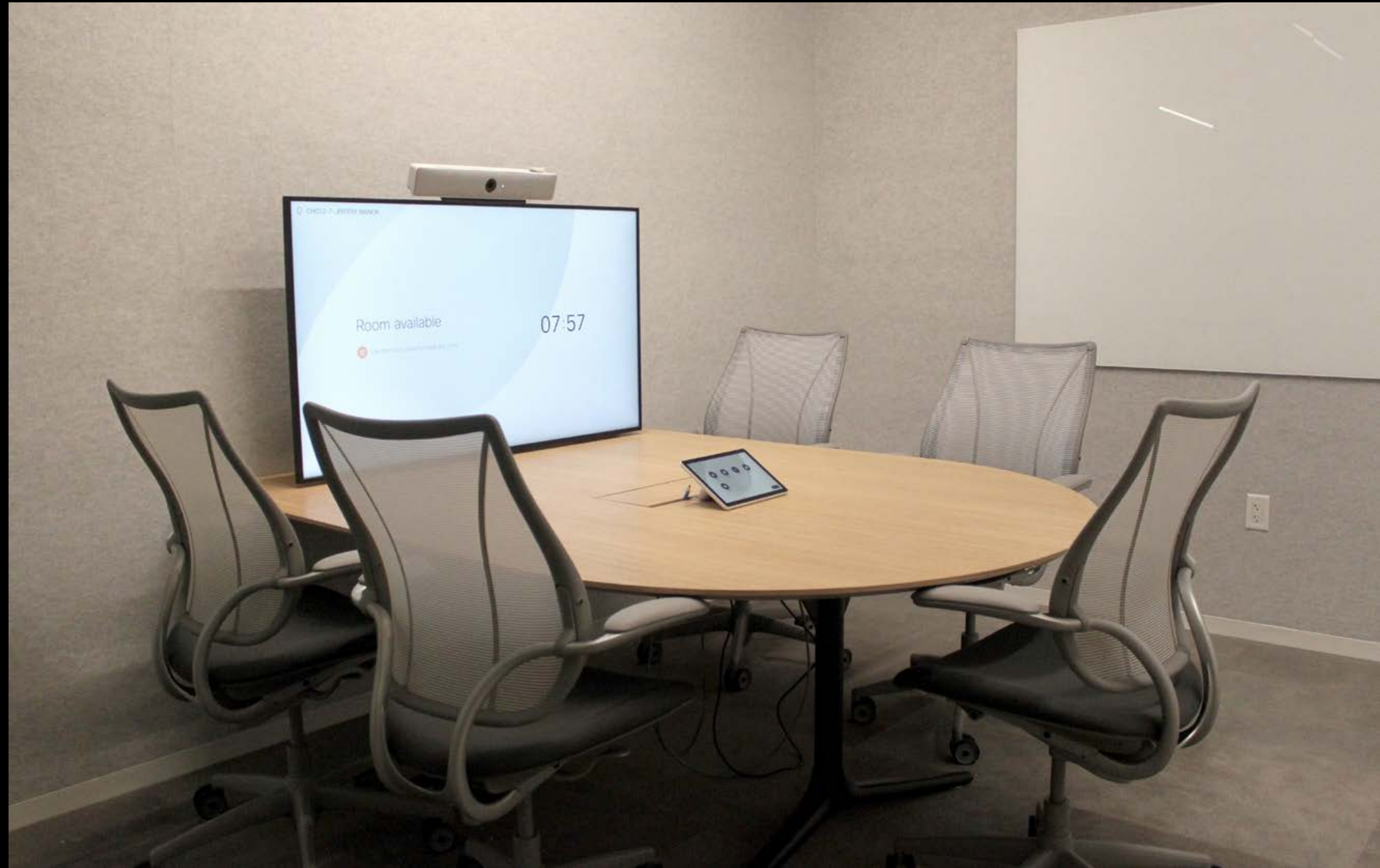

# Small Collaboration Room Components



## Humanscale Liberty Task Chair

**Armrest/Armpad**  
Fixed Duron Arms

**Frame Color**  
Silver with Silver Trim

**Back Mesh**  
Pinstripe (Color: White)

**Seat Textile**  
Fourtis (Color: Granite Box Stitching)

\_\_\_\_\_ Humanscale



## Cisco Room Bar

\_\_\_\_\_ CISCO



## Single 55" display

(LG, Panasonic, Samsung, or Sony)

\_\_\_\_\_ LG Panasonic SAMSUNG SONY

## Nienkamper Gateway TB-09



Table with Trapezoid Top, (1) simple forum with wood trough-6 ports

72" L x 32"/55" D x 28-1/2" H  
(1829mm L x 813/1397mm D x 724mm H)

**Wood finish top**  
#F18 Natural White Oak

**Leg finish**  
Black



Power Forum finish  
Black

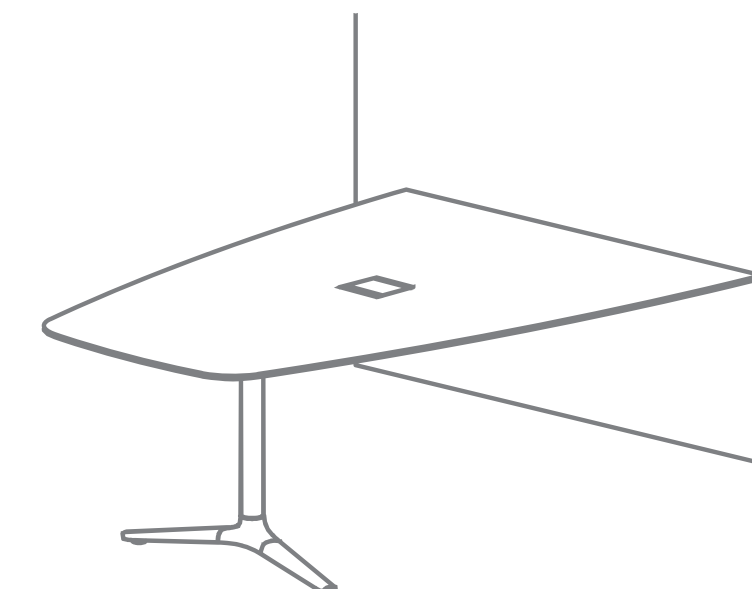

\_\_\_\_\_ nienkamper

# Small Collaboration Room

## Room Layout

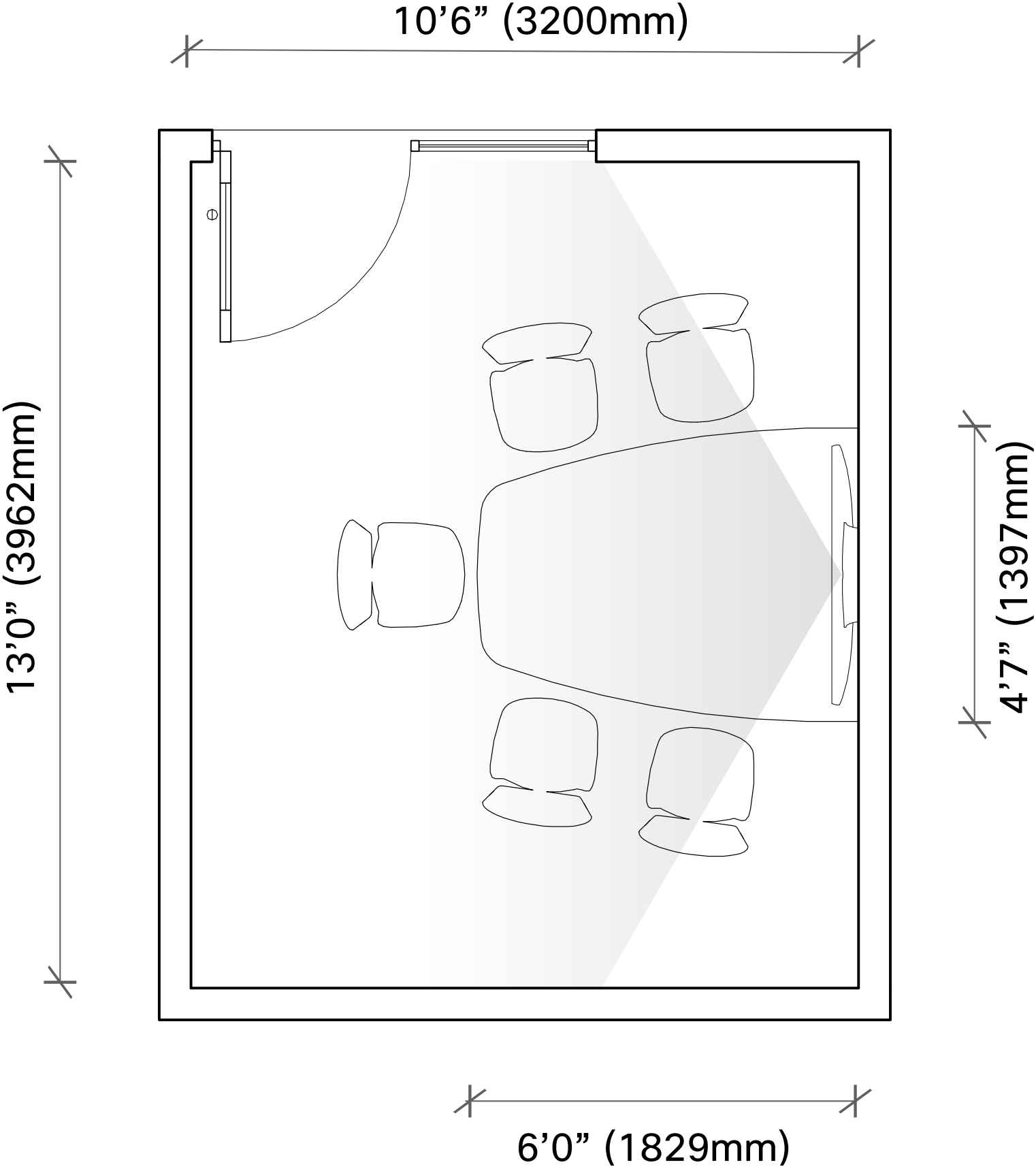

# Medium Collaboration Room - Dual Display

## Overview



The perfect space to bring people together for knowledge sharing or decision making, dual 55" displays allow you to see content and remote participants simultaneously. Trapezoid shaped table ensures everyone can be seen.

### Features

- Wall mounted Cisco Room 55D (or Cisco Room Kit EQ with dual 55" displays)
- Nienkamper Vox table
- Humanscale Liberty Task chairs

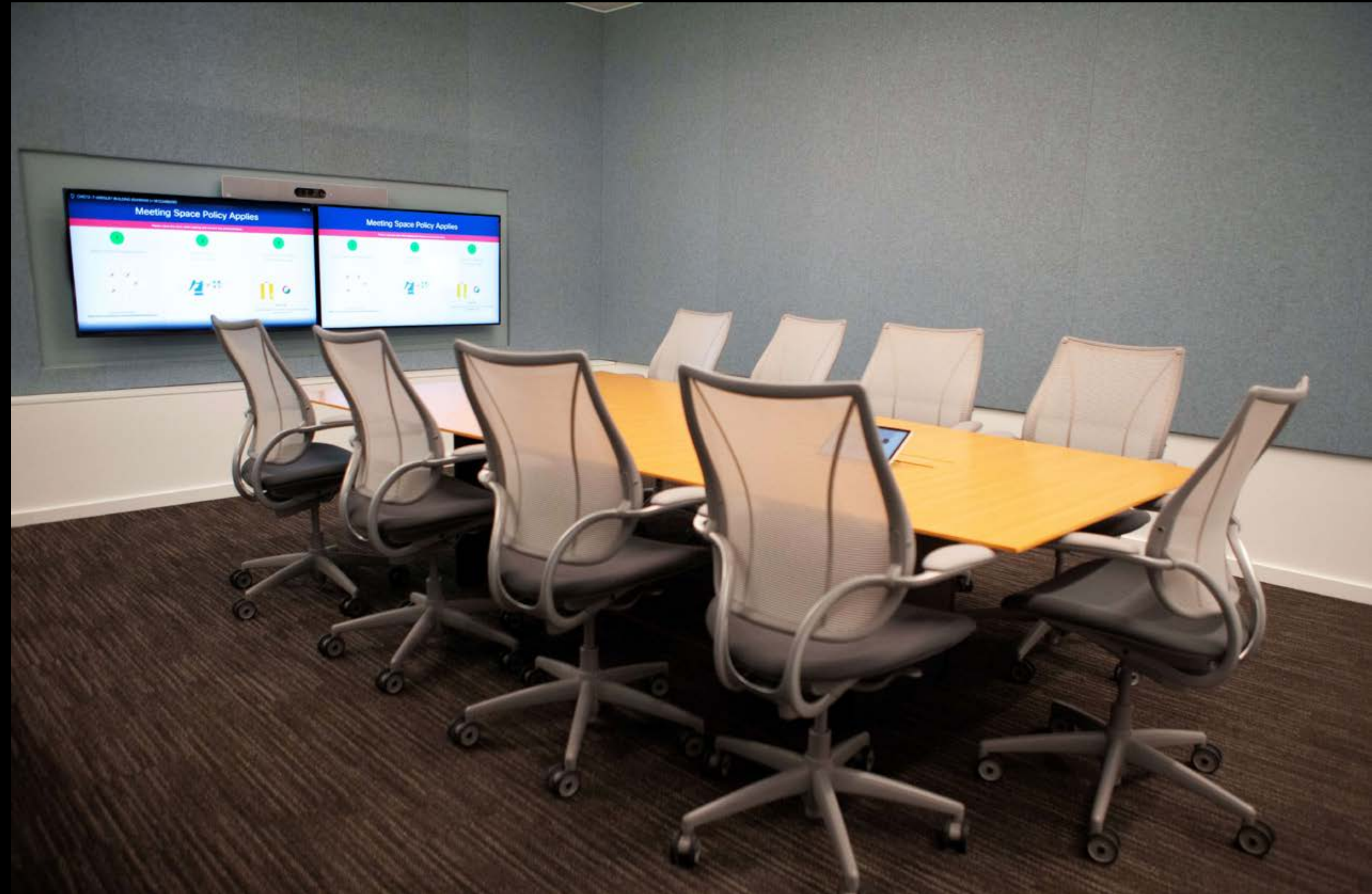

# Medium Collaboration Room - Dual Display

## Components



### Humanscale Liberty Task Chair

- Armrest/Armpad  
Fixed Duron Arms
- Frame Color  
Silver with Silver Trim
- Back Mesh  
Pinstripe (Color: White)
- Seat Textile  
Fourtis (Color: Granite Box Stitching)

Humanscale

### Nienkamper Vox Table TB-15



Table with Trough: Rectangle Shape and Laminate Top  
 Accessible Duo bases to conceal stub-up  
 120" L x 48" D x 28-1/2" H  
 (3048mm L x 1219mm D x 724mm H)

Laminate top  
 Wilsonart Natural Rift 7954-38, Fine Velvet Finish

Base  
 Black

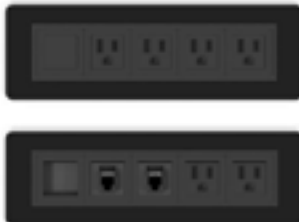

Two Power modules  
 5 ports  
 Power Forum finish  
 Black

nienkämper

### Option 1

#### Cisco Room 55D



CISCO

### Option 2

#### Cisco Room Kit EQ



CISCO

#### Dual 55" Displays

(LG, Panasonic, Samsung, or Sony)



LG Panasonic SAMSUNG SONY

# Medium Collaboration Room - Dual Display

## Room Layout

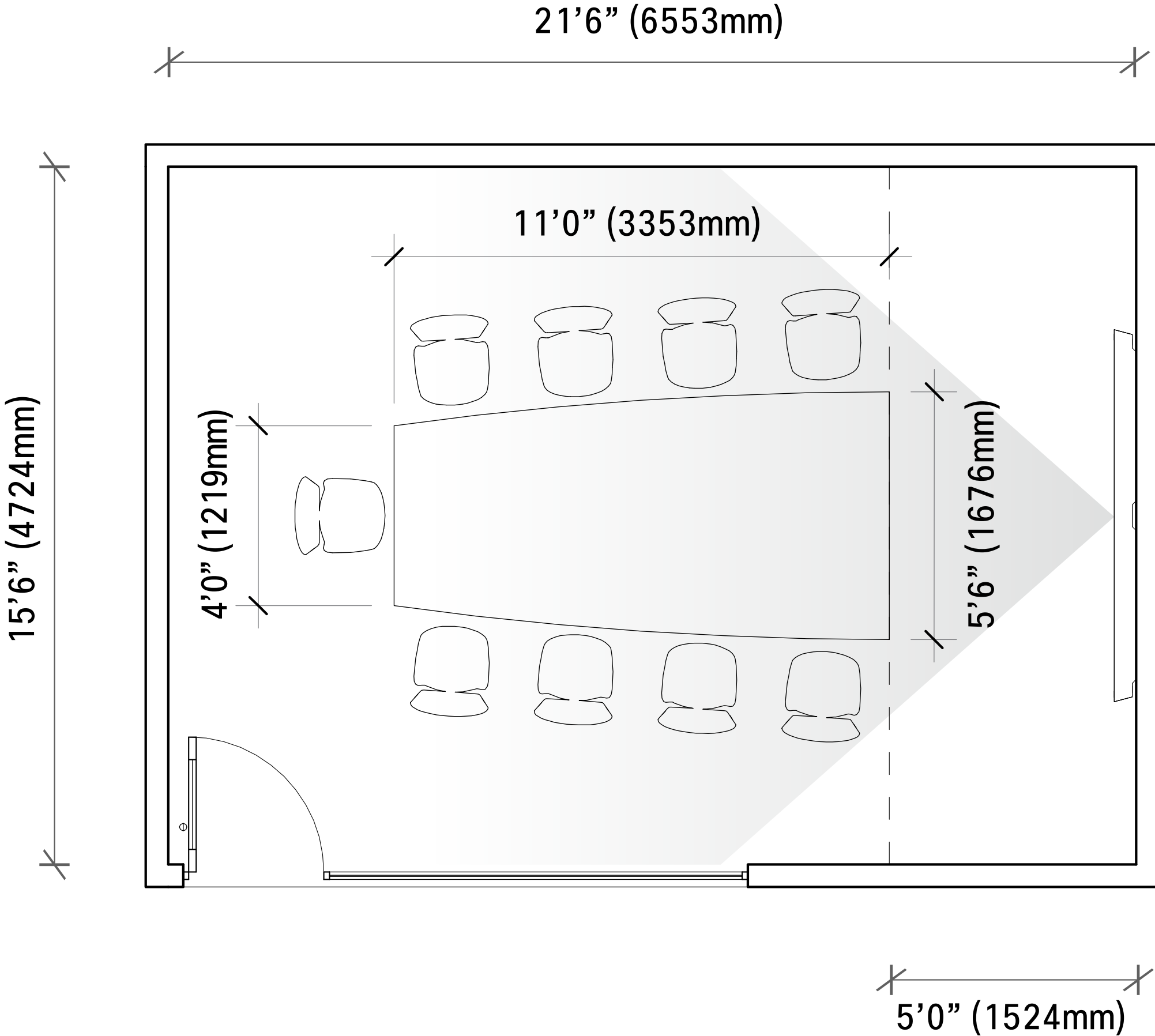

# Medium Brainstorming Room

## Overview



This brainstorming space is built for when larger groups need to ideate. The Cisco Board is multi-functional, enabling video calls, content sharing, and whiteboarding. Mounting of technology to the Salamander Credenza simplifies initial installation and future upgrade.

### Features

- Cisco Board Pro 75 mounted on a Salamander Low Profile Credenza
- Nienkamper Vox table
- Humanscale Liberty Task Chairs



# Medium Brainstorming Room

## Components



Humanscale Liberty Task Chair

- Armrest/Armpad  
Fixed Duron Arms
- Frame Color  
Silver with Silver Trim
- Back Mesh  
Pinstripe (Color: White)
- Seat Textile  
Fourtis (Color: Granite Box Stitching)

Humanscale

Nienkamper Vox (TB-20A)



- Table with Standing Height & Trough Trapezoid Shape
- 108" L x 78/66" D x 38" H (2743mm L x 1981/1676mm D x 965mm H)
- Laminate top  
Wilsonart-Natural Rift 7954-38, fine velvet finish
- Base  
Black
- Power Forum finish  
Black

nienkämper

Salamander Low Profile Credenza



- XU/CSO/347B85/XX/XX
- Ultra Low Profile  
85.5" L x 5" D x 30" H (2172mm L x 127mm D x 762mm H)
- 4 Bay
- Standard Shelves all bays
- Chicago finish



SALAMANDER  
DESIGNS

Cisco Board Pro 75

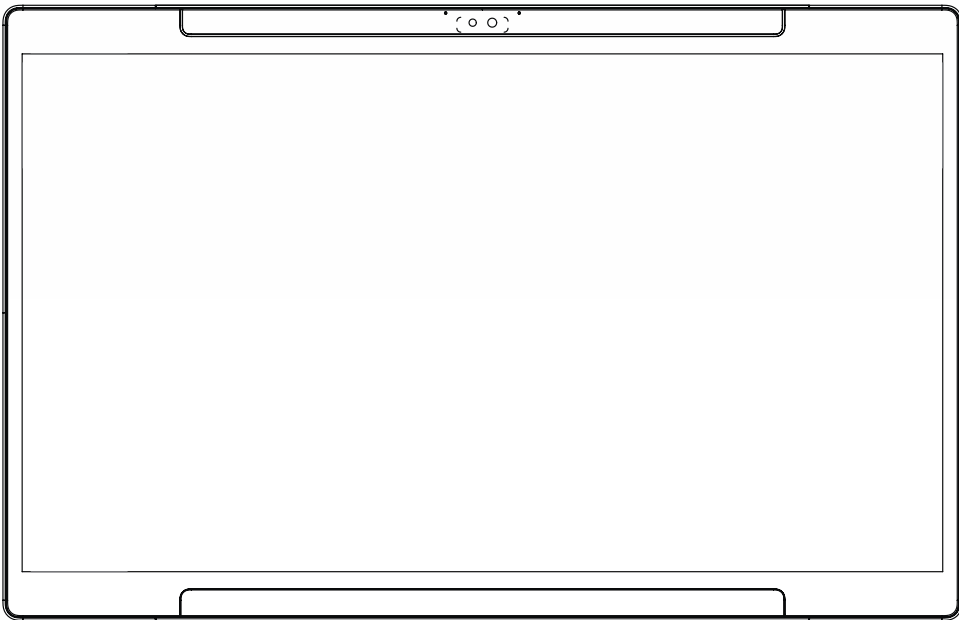

CISCO

# Medium Brainstorming Room

## Room Layout

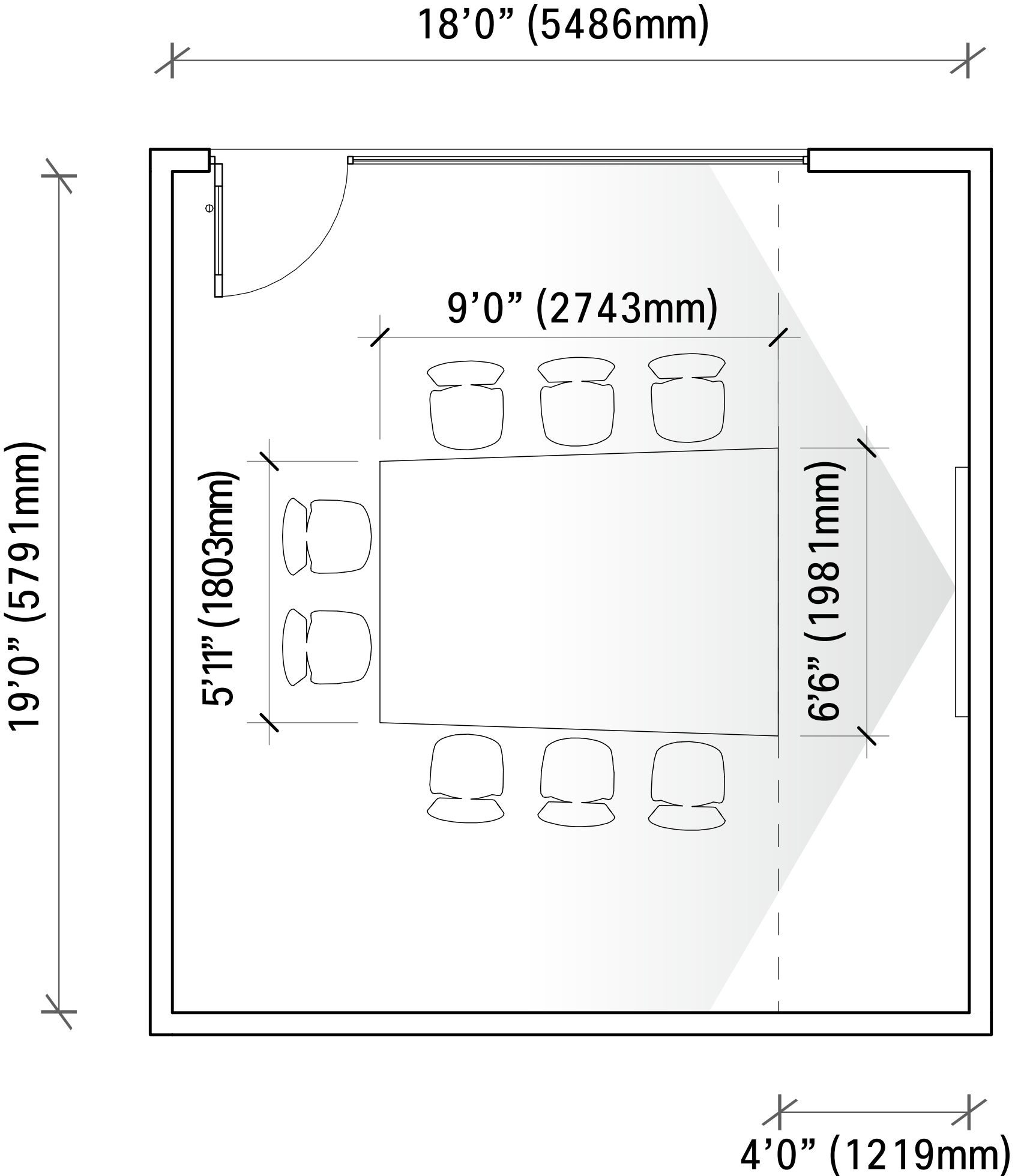

# Large Collaboration Room

## Overview



The perfect space to bring people together for knowledge-sharing or decision-making activities. Triple 75" displays in the front of the room provide ample screen space to see content and remote participants simultaneously, and the tapered-shaped table ensures that everyone has an unobstructed view of those in the room and those who are remote. In addition, two (2) Cisco Quad Cameras mounted on the side walls, combined with 65" displays, support the Cisco's Cross View capability.

### Features

- A wall mounted Cisco Room Kit EQX with dual 75" displays, with an additional 75" display mounted above
- Two (2) side-mounted Cisco Quad Cameras
- Side mounted 65" auxiliary displays
- Four (4) Cisco Table Microphone Pros
- Nienkamper Vox table
- Humanscale Freedom Task Chairs with headrests



# Large Collaboration Room

## Components



Cisco Room Kit EQX  
Wall Mount



Humanscale Freedom  
Task Chair with Headrest



Armrest/Armpad  
Advanced Duron Arms  
with Textile

Frame Color  
Graphite

Seat Textile  
Ticino Charcoal with light  
Grey Stitch

Humanscale

Nienkamper Vox Conference Table



Cisco Table Microphone Pro



Cisco Quad Cameras (x2)  
for Cross View

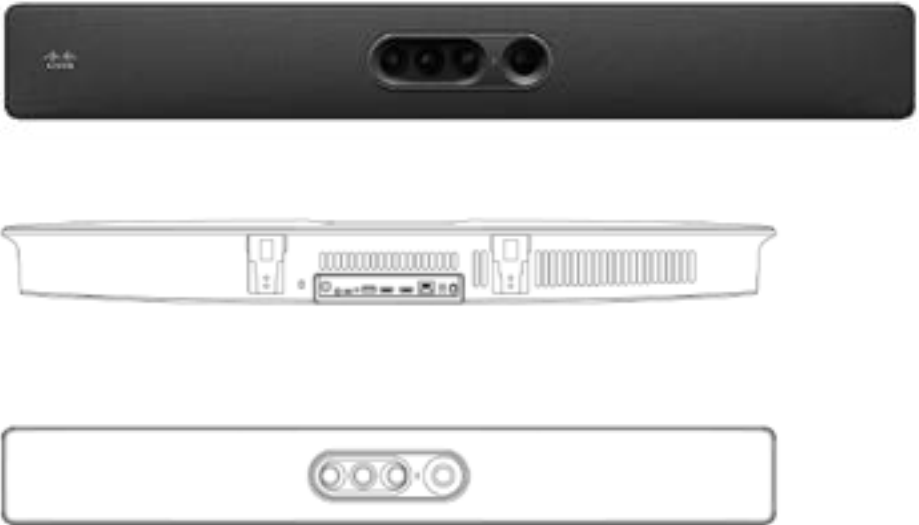

75" Primary Displays  
65" Auxiliary Display

(LG, Panasonic, Samsung, or Sony)



LG Panasonic SAMSUNG SONY

Vox Conference Table with Trough  
Vista (Closed) Shape

120" L x 66/48" D x 28-1/2" H  
(3048mm L x 1676/1219mm D x 724mm H)

Wood finish top  
#F18 Natural White Oak

Base and Ends  
Black

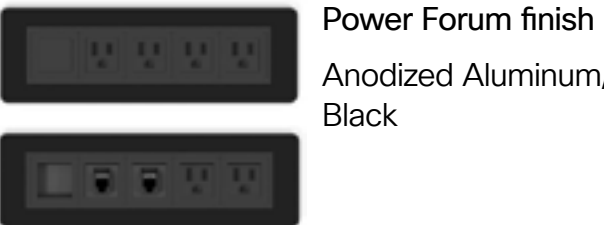

Power Forum finish  
Anodized Aluminum/  
Black

nienkamper

CISCO

# Large Collaboration Room

## Room Layout

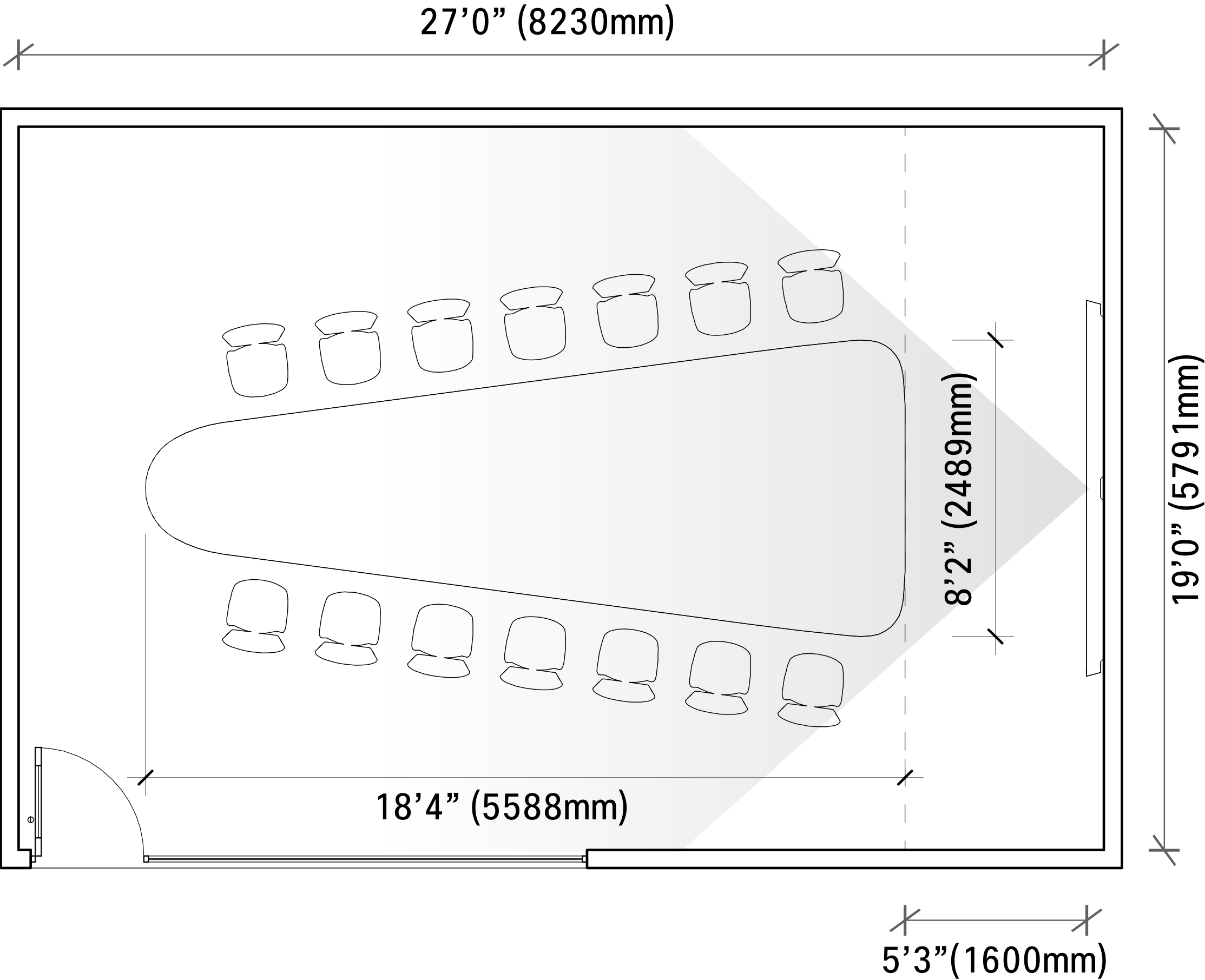

# Extra Large Briefing Room

## Overview



The Chicago Talent and Collaboration Center is a destination for Cisco employees, customers, and partners. Thus, having space to accommodate large groups is critical. This boardroom uses some of our latest technology innovations from our team in Oslo. Large displays, driven by a Room Kit Pro and a Cisco Board Pro running in companion mode, create a new collaboration experience.

### Features

- Cisco Room Kit Pro
- Wall mounted Cisco Quad Cam
- Dual 98" displays
- Audio Science ceiling microphones
- JBL or Extron Soundfield (26CT) ceiling speakers with amplifier
- Rear mounted Cisco PTZ 4K camera
- Wall mounted Cisco Board Pro 75
- Nienkamper Congress table
- Humanscale Freedom chairs with headrests



# Extra Large Briefing Room

## Components



**Humanscale Freedom chairs with headrests**

Polished Metal Base  
White Leather Upholstery  
With Headrest

Humanscale

**Cisco Board Pro 75**



**Cisco PTZ 4K Camera**



**Dual 98" displays**  
(LG, Panasonic, Samsung, or Sony)



**Nienkamper Congress with Custom Base**



Table with Custom Base & Trough  
Congress (Open) Shape  
240" L x 180" D x 29" H  
(6096mm L x 4572mm D x 737mm H)  
Wood finish top  
#F18 Natural White Oak  
Base  
#F18 Natural White Oak



Power Forum finish  
Black



nienkämper

**Cisco Room Kit Pro with Cisco Quad Camera**



**Cisco Audio Sciences Microphones**



CISCO

LG Panasonic SAMSUNG SONY

# Extra Large Briefing Room

## Room Layout

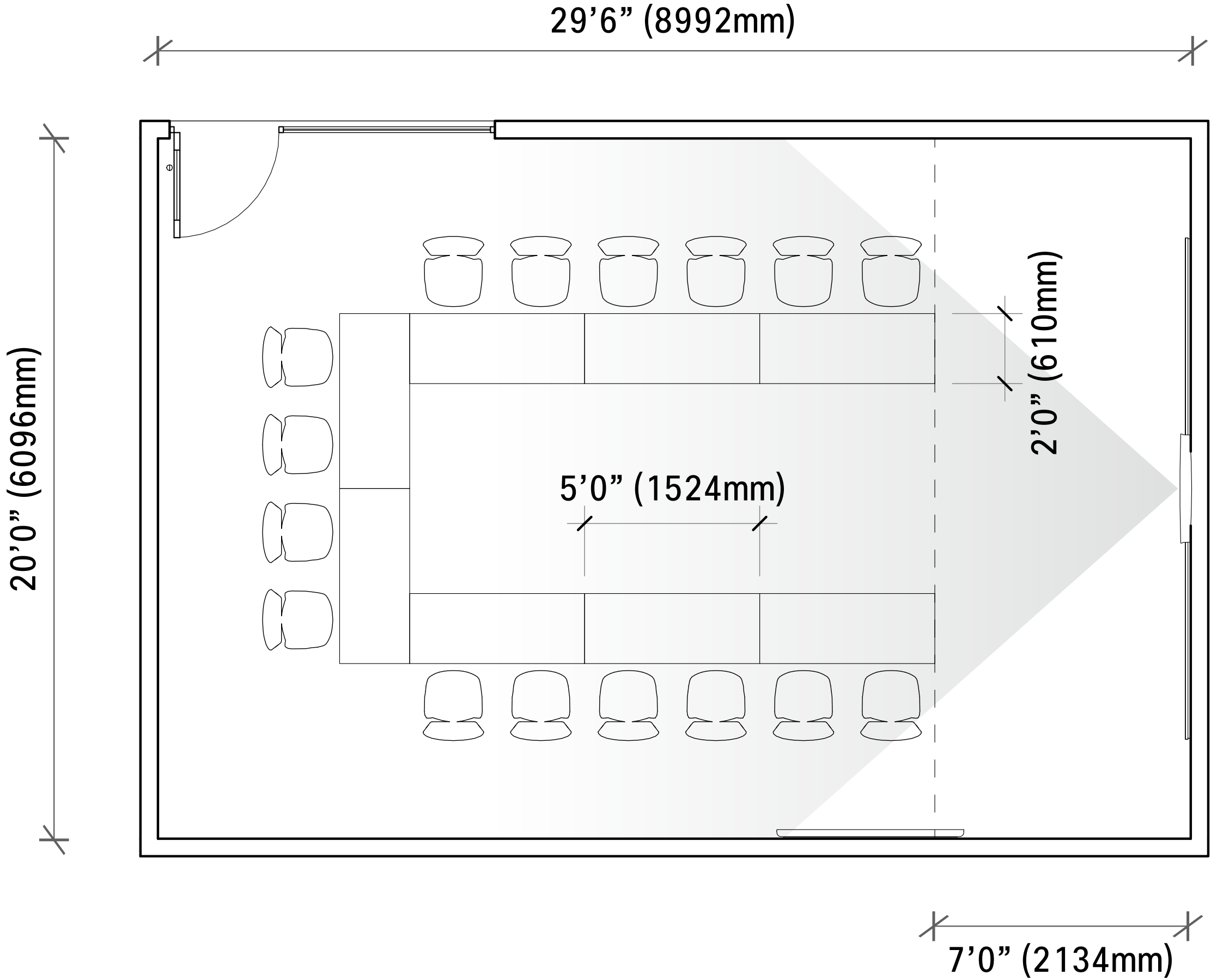



## Resources

[Cisco.com](https://www.cisco.com)

[Cisco Workspaces](#)

[Best Practices for Creating Effective Video-enabled Rooms](#)

© 2025 Cisco and/or its affiliates. All rights reserved. Cisco, the Cisco logo, Webex by Cisco, and Webex are trademarks or registered trademarks of Cisco and/or its affiliates in the U.S. and other countries. To view a list of Cisco trademarks, see the Trademarks page on the Cisco website. Third-party trademarks mentioned are the property of their respective owners. The use of the word “partner” does not imply a partnership relationship between Cisco and any other company. (2106R)

The intent of this document is to highlight the details, components and partners used in the creation of this office. Any reference herein to any specific commercial products or service does not necessarily constitute or imply its endorsement or recommendation.